

Name	VS44_0191500x400 44 Elton		
Zeichnung/Drawing	3D		
Profil/Profile	4.4x13.5	Datum/Date	26.06.2024

H = 1.600 m
TOTAL: 17.49 m²

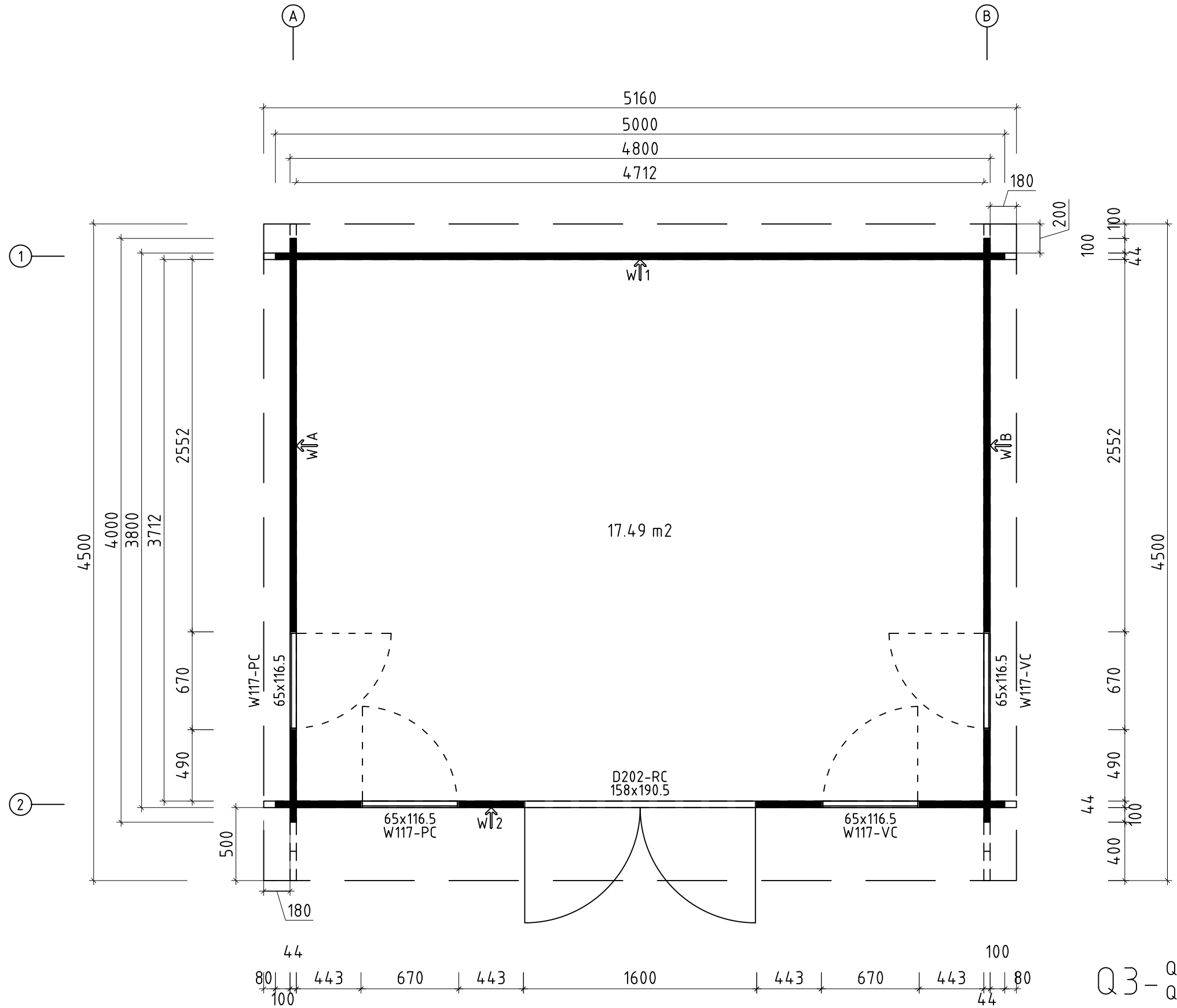

Q3 – Qualitätsklasse für Fenster und Türen/
Quality class for windows and doors

* Fenster und Türen sind mit Sprossen/
Windows and doors are with muntins

Name	VS44_0191 500x400 44 Elton		
Zeichnung/Drawing	Grundplan - Floor plan		
Profil/Profile	4.4x13.5	Datum/Date	26.06.2024

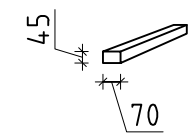
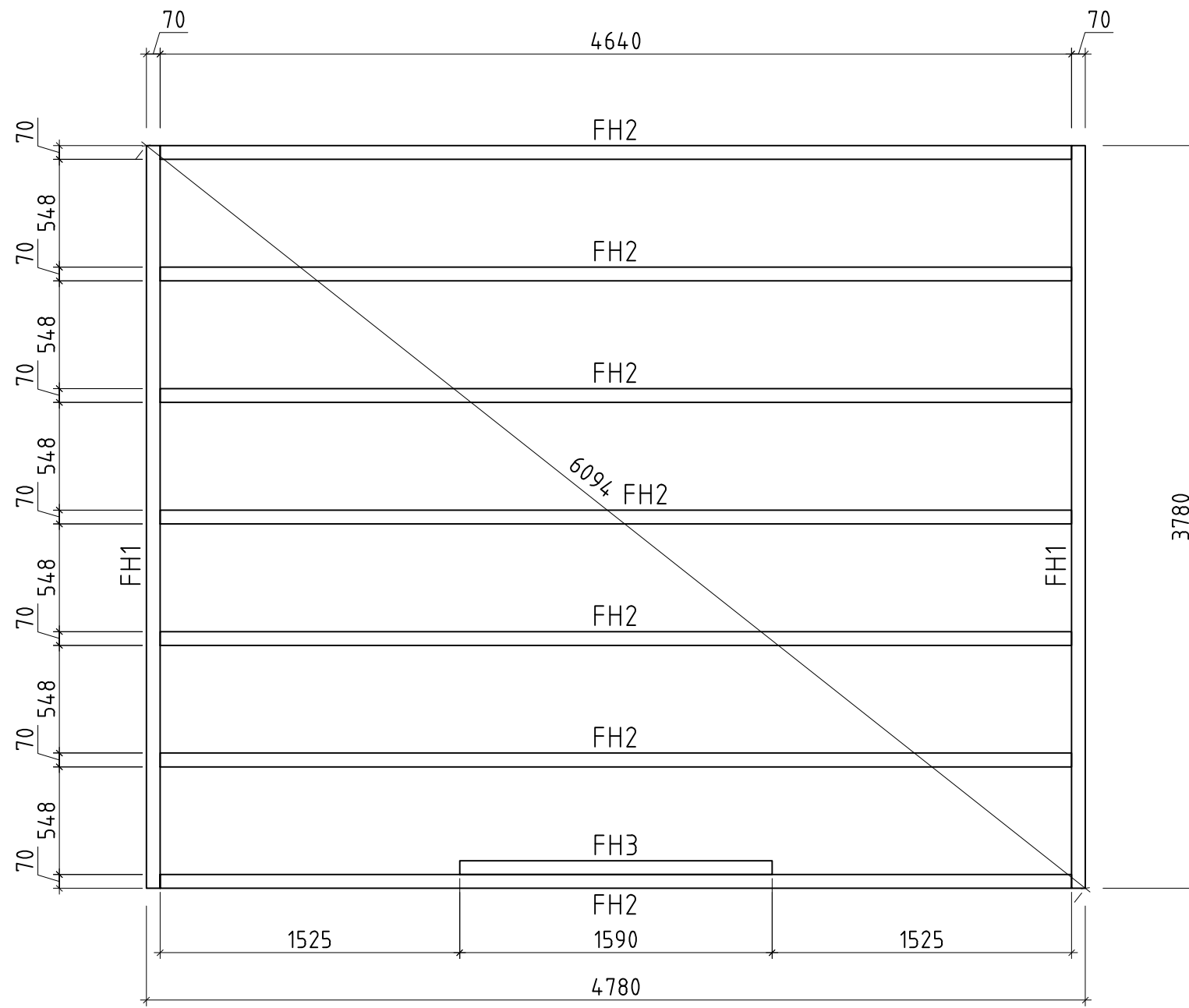

Name	VS44_0191 500x400 44 Elton		
Zeichnung/Drawing	Lagerholzplan - Foundation beam plan		
Profil/Profile	4.4x13.5	Datum/Date	26.06.2024

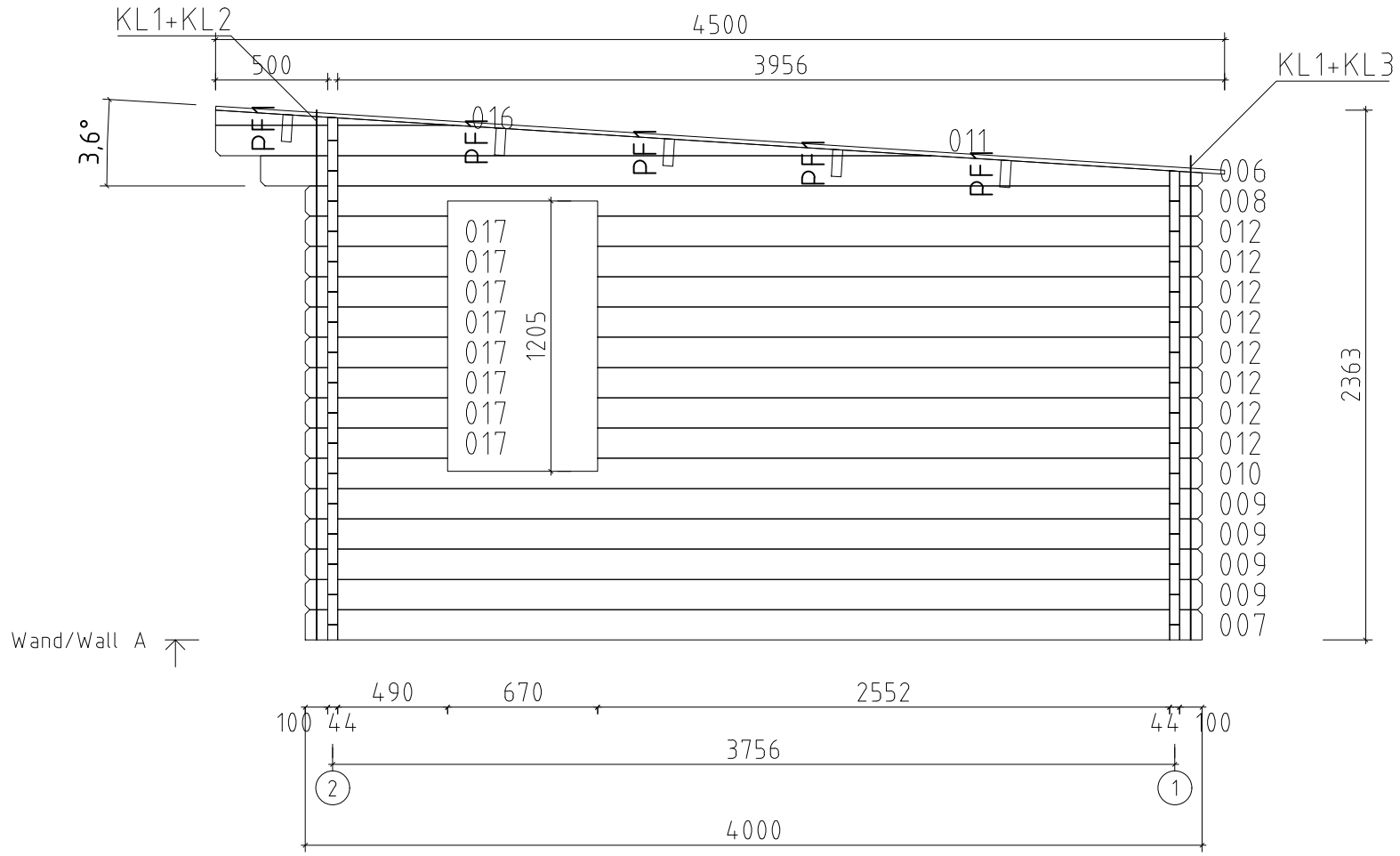

Name	VS44_0191 500x400 44 Elton		
Zeichnung/Drawing	WAND/WALL A		
Profil/Profile	4.4x13.5	Datum/Date	26.06.2024

- Taufendeckleisten
- Eaves cover strips
- Dachbretter
- Roof boards
- Traufenleisten
- Eaves strips
- Traufenbretter
- Eaves boards

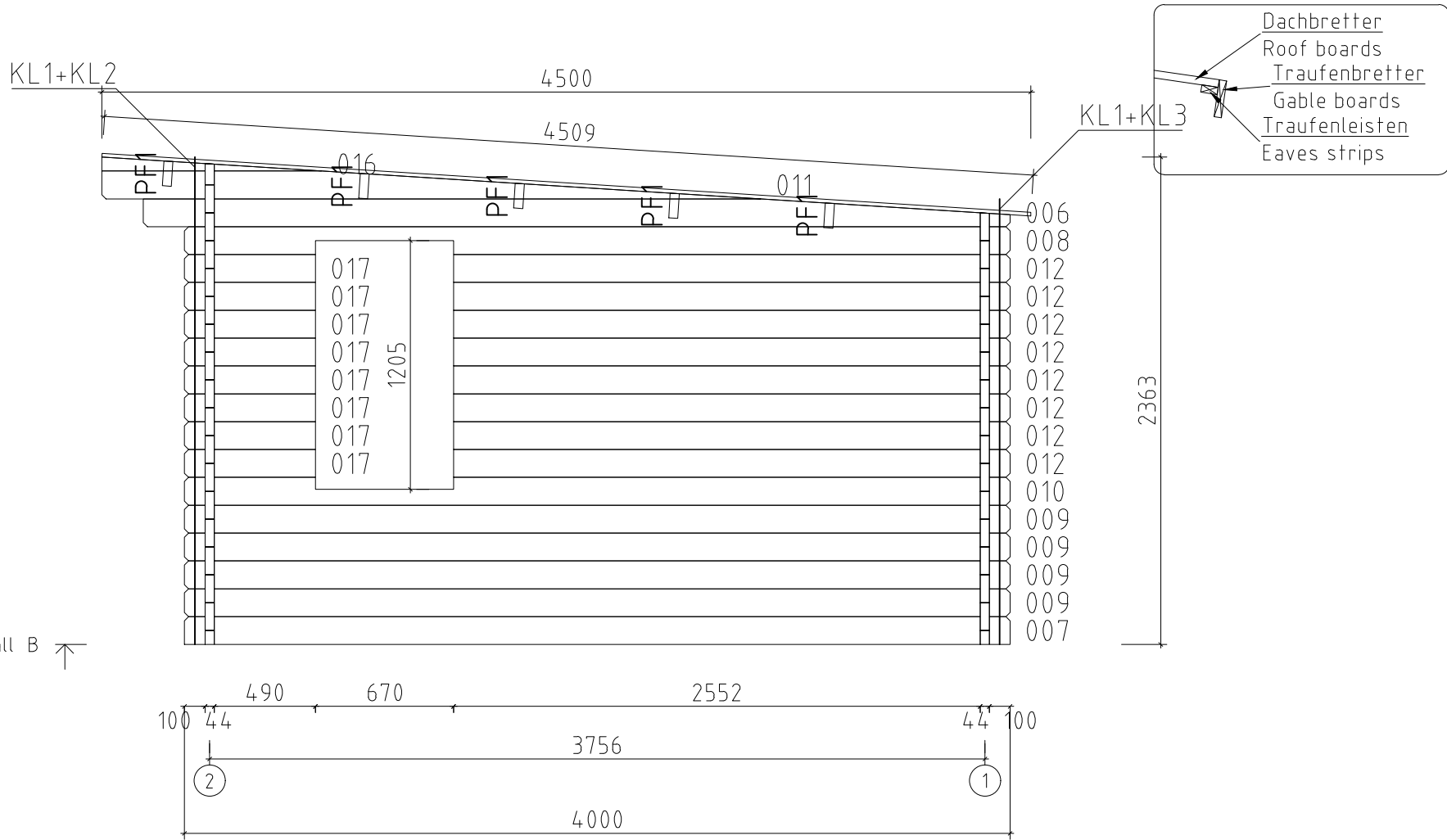

- Dachbretter
- Roof boards
- Traufenbretter
- Gable boards
- Traufenleisten
- Eaves strips

Wand/Wall B ↑



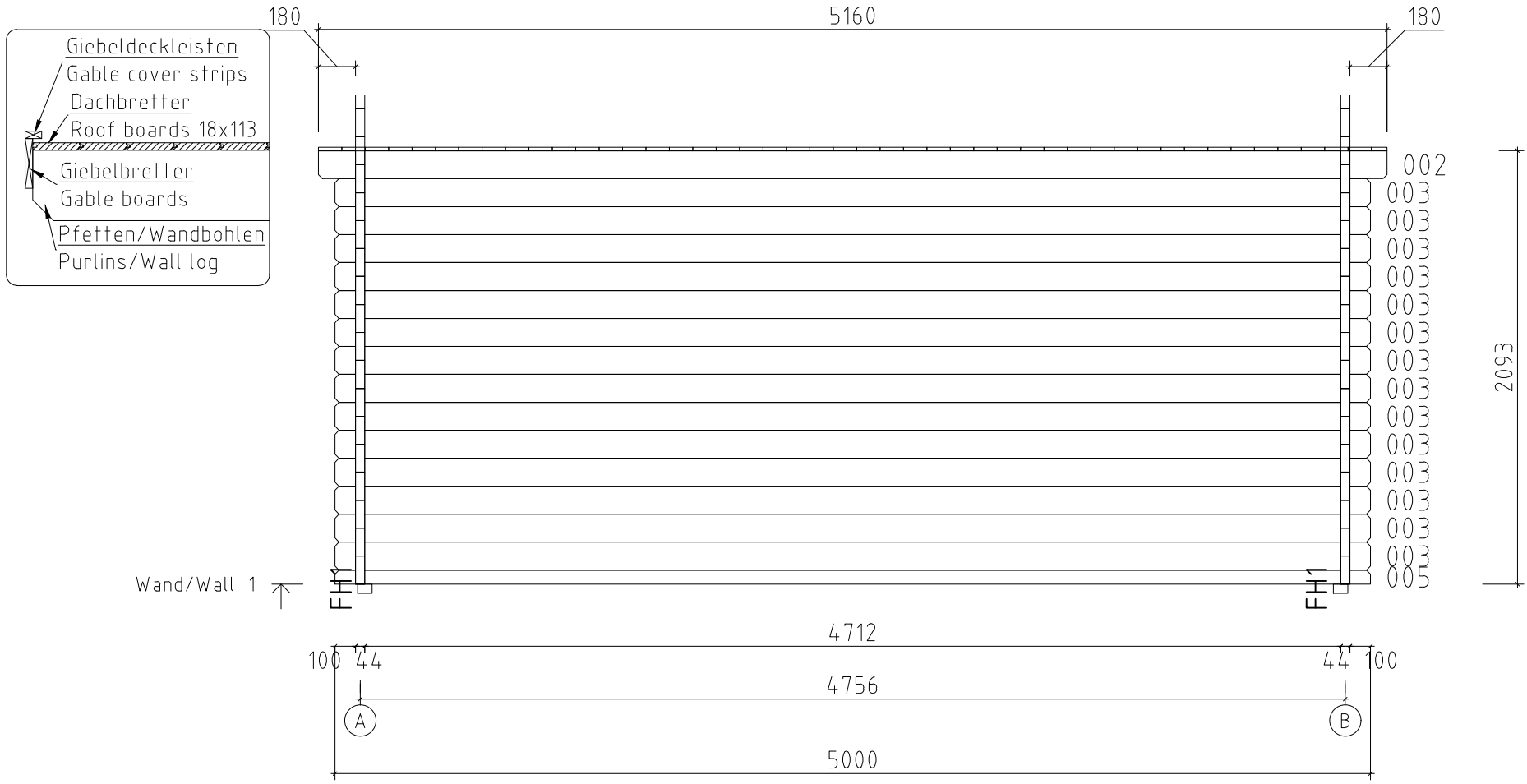



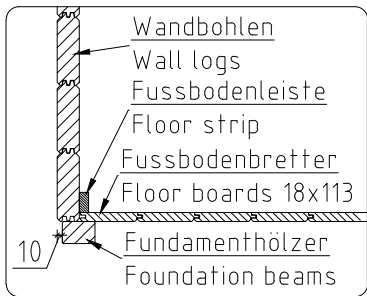
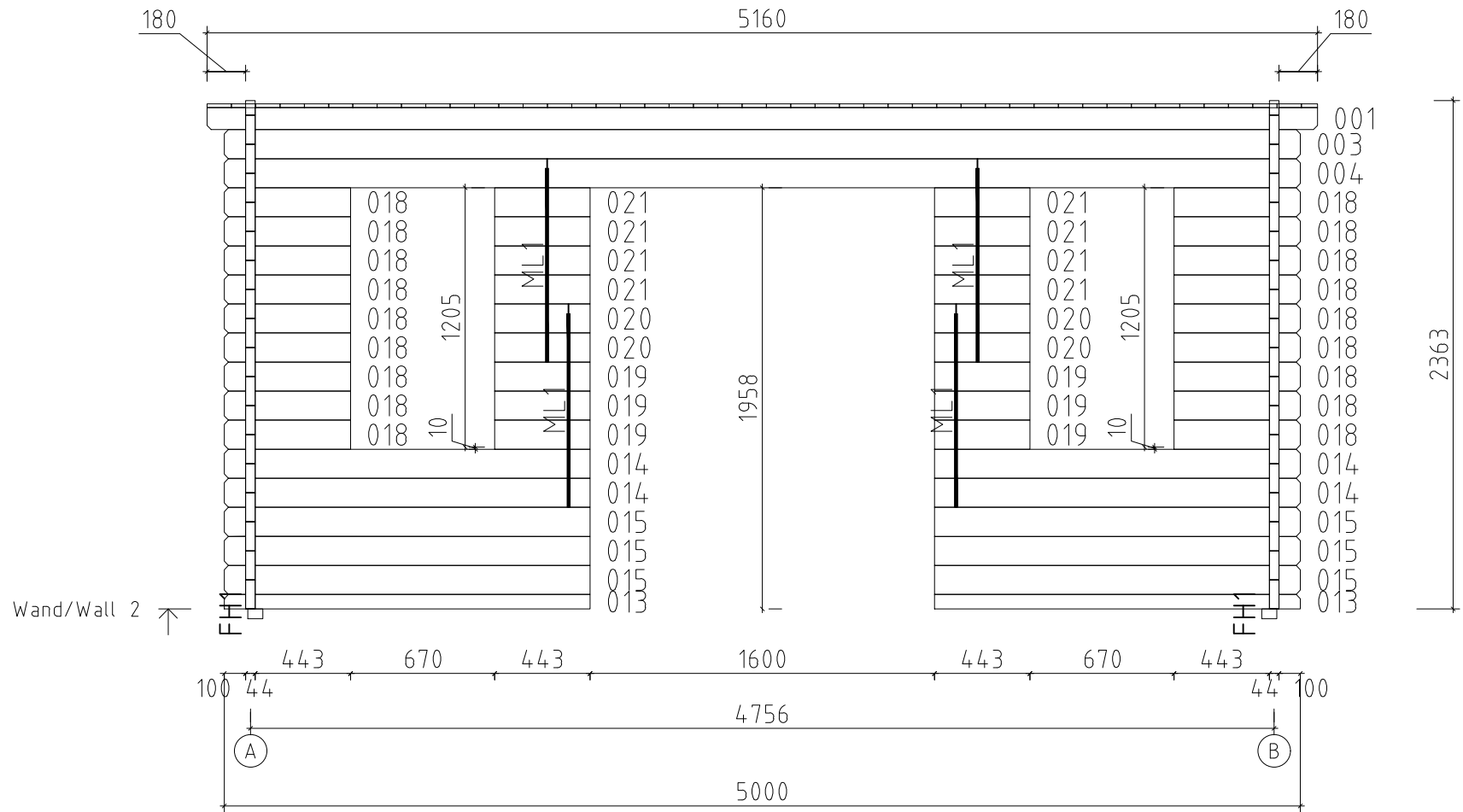



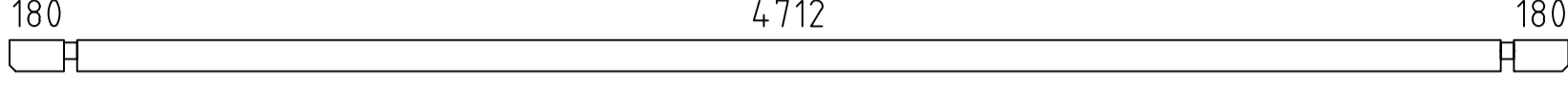
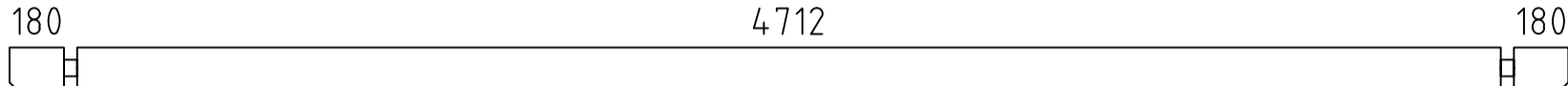
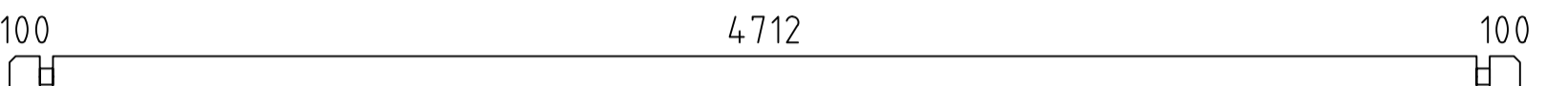
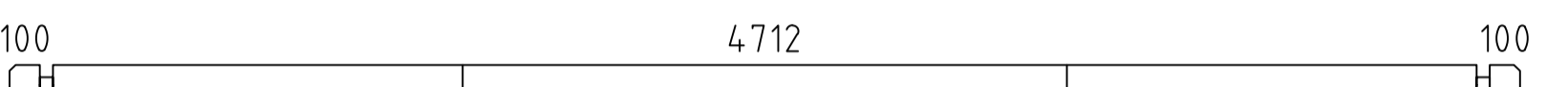
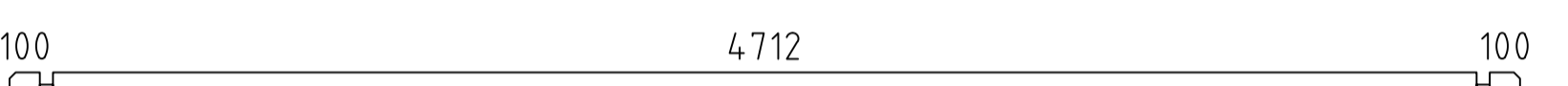

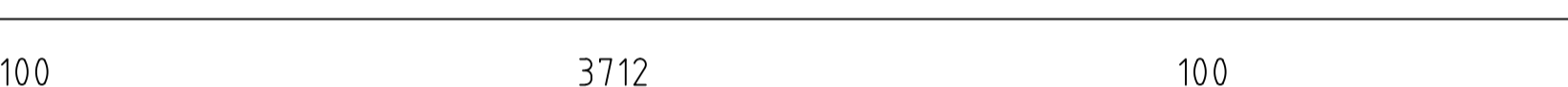
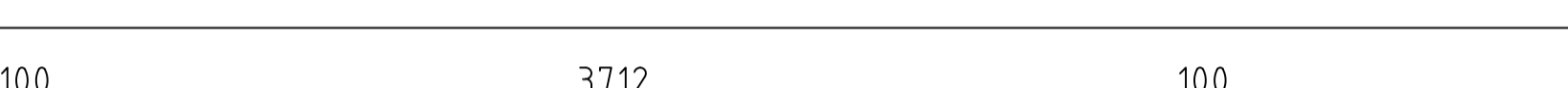

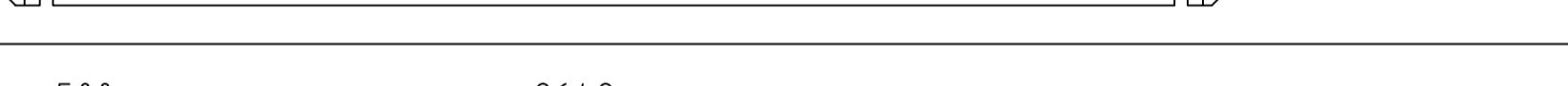
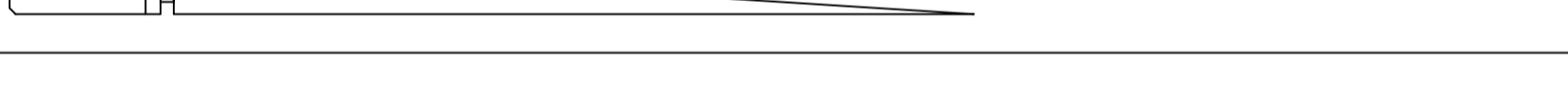
Name	VS44_0191 500x400 44 Elton		
Zeichnung/Drawing	WAND/WALL B		
Profil/Profile	4.4x13.5	Datum/Date	26.06.2024

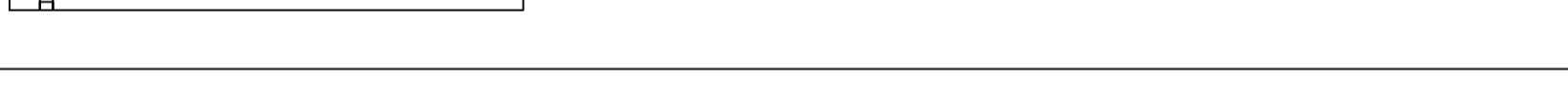









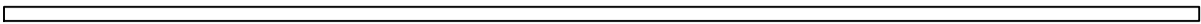
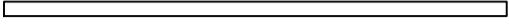
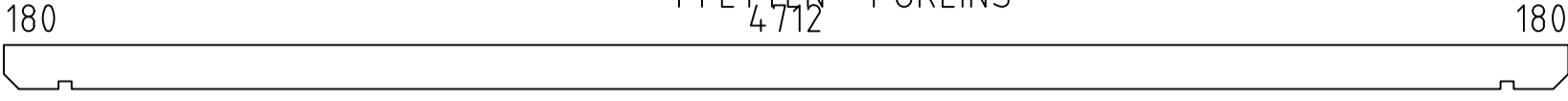
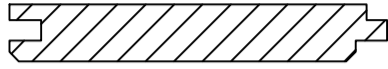

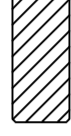

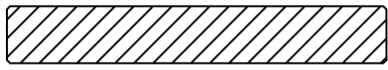
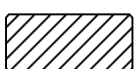

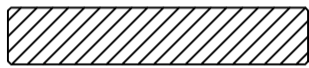
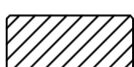
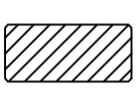
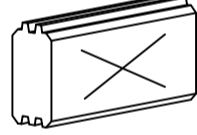

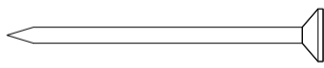
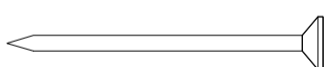
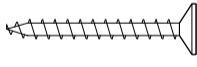
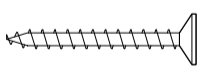
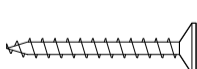
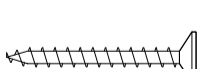
Name	VS44_0191 500x400 44 Elton		
Zeichnung/Drawing	WAND/WALL 1		
Profil/Profile	4.4x13.5	Datum/Date	26.06.2024

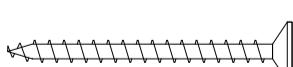

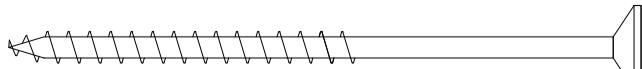

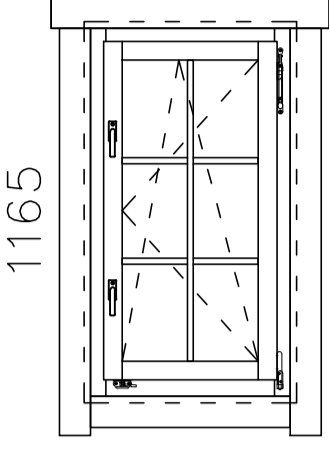
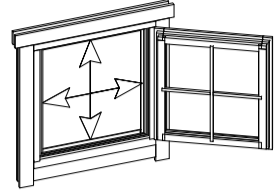
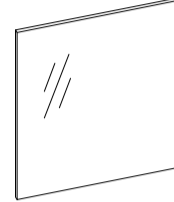
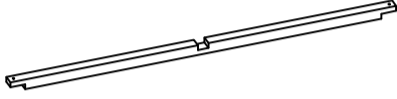

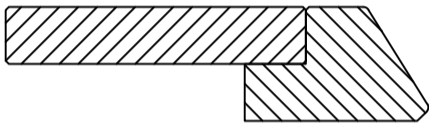
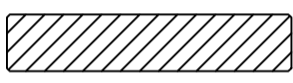
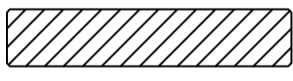
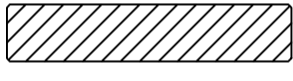
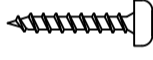
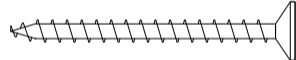

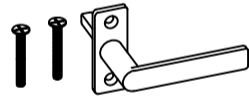

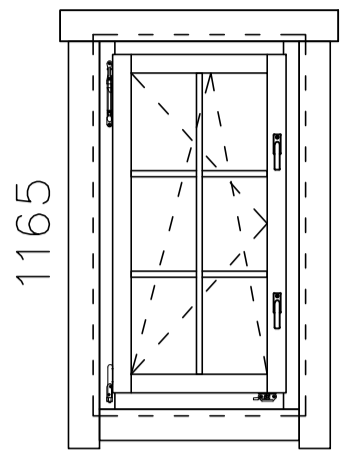
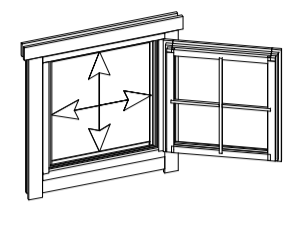
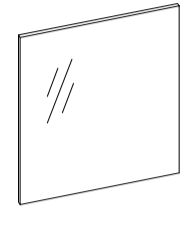
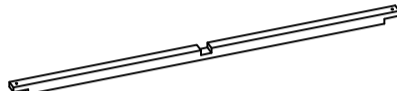

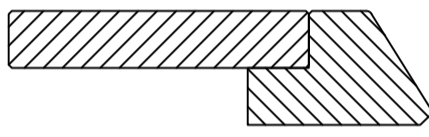
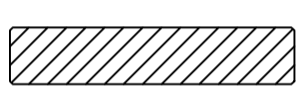
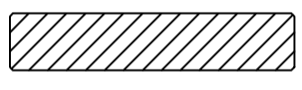

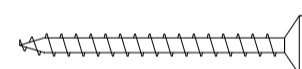
Name	VS44_0191 500x400 44 Elton	
Zeichnung/Drawing	WAND/WALL 2	
Profil/Profile	4.4x13.5	Datum/Date
		26.06.2024

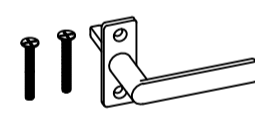
Pos	Teileliste/Specification VS44_0191 500x400 44 Elton	Stck./Pcs.	Profil/Pröfilänge/Leht (mm)	Stange/Len (mm)
	<u>Achtung!</u> Die Giebelbohlen können teilweise schon vormontiert sein! Bitte beachten - diese erscheinen nicht ganz so wie in der Teileliste beschrieben.			
	<u>Notice!</u> The gable pieces can be partly pre-assembled! Please notice - those differ from the description given in the specification list.			
Extra1		1	44x135	5160
001		1	44x103	5160
002		1	44x135	5160
003		15	44x135	5000
004		1	44x135	5000
005		1	44x68	5000
006		2	44x135	4200
007		2	44x135	4000
008		2	44x135	4000
009		8	44x135	4000
010		2	44x135	4000
011		2	44x135	3192
012		16	44x135	2696
013		2	44x68	1700
014		4	44x135	1700
015		6	44x135	1700
016		2	44x68	1064
017		16	44x135	634
018		18	44x135	587
019		6	44x135	443
020		4	44x135	443
021		8	44x135	443
FH2	FUNDAMENTHOLZ (imprägniert) - FOUNDATION BEAM (impregnated) 	7	70x45	4640
Kood	VS44_0191 500x400 44 Elton	Materjal		Leht 1/6

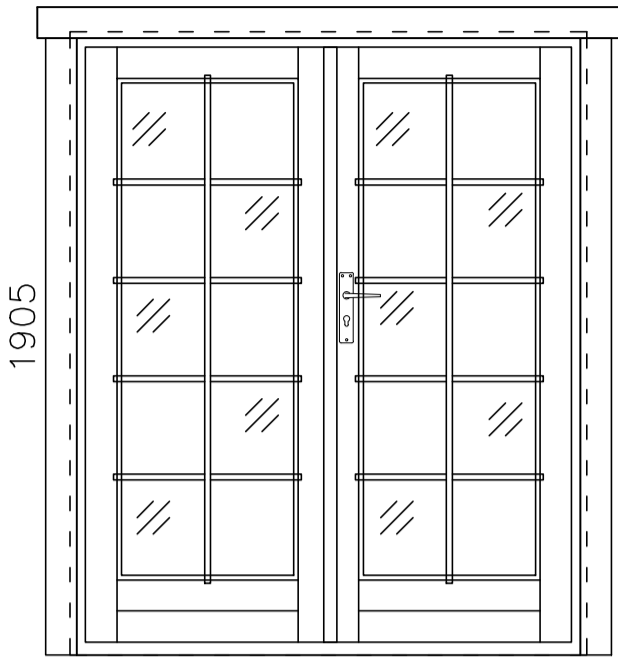
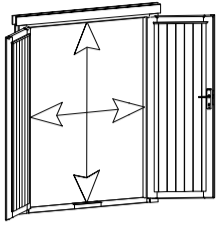
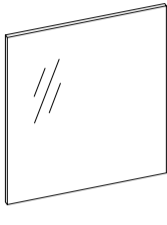
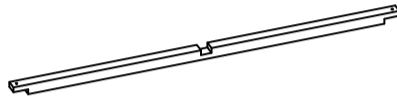
Pos	Teileliste/Specification VS44_0191 500x400 44 Elton	Stck./Pcs.	Profil/Pröfilänge/Leht (mm)	Stärke/Länge (mm)
FH1	FUNDAMENTHOLZ (imprägniert) - FOUNDATION BEAM (impregnated) 	2	70x45	3780
FH3	FUNDAMENTHOLZ (imprägniert) - FOUNDATION BEAM (impregnated) 	1	70x45	1590
PF1	PFETTEN - PURLINS 180  180	5	44x145	5160
	DACHBRETTER - ROOF BOARDS 	46+1	113x18	4509
	FUSSBODENBRETTER - FLOOR BOARDS 	42+1	113x18	3707
	FUSSBODENLEISTEN - FLOOR STRIPS  ✓		18x40	19.0 lfm/rm
	DECKENLEISTEN - CEILING STRIPS  ✓		15x28	22.0 lfm/rm
G02-1	GIEBELBRETTER - GABLE BOARDS 18x120 3.6°  ✓	2	18x120	4529
G05-1	GIEBELDECKLEISTEN - GABLE COVER STRIPS 18x40  ✓	2	18x40	4509
T02-1	TRAUFBRETTER - EAVES BOARDS 18x120 	1	18x120	5200
T01-1	TRAUFBRETTER - EAVES BOARDS 18x95 	1	18x95	5160
T04-1	TRAUFENDECKLEISTEN - EAVES COVER STRIPS 18x40 	2	18x40	2600
T06-1	TRAUFENLEISTEN - EAVES STRIPS 18x40  ✓		18x40	11.0 lfm/rm
SH	SCHLAGHÖLZER - MOUNTING PIECES 	3		
ML1	Metallstange - Metal bar 	4	D10	900
NG2 550	NÄGEL - NAILS 2.5x50 Dachbretter - Roof boards 	644		
NG2 550	NÄGEL - NAILS 2.5x50 Fussbodenbretter - Floor boards 	588		
SR3 030	Schrauben - Screws 3.0x30 Deckenleisten - Ceiling strips 	38		
SR3 030	Schrauben - Screws 3.0x30 Fussbodenleisten - Floor strips 	34		
SR3 030	Schrauben - Screws 3.0x30 Giebeldeckleisten - Gable cover strips 	18		
SR3 030	Schrauben - Screws 3.0x30 Traufendeckleisten - Eaves cover strips 	10		
SR3 030	Schrauben - Screws 3.0x30 Traufenleisten - Eaves strips 	20		
SR3 545	Schrauben - Screws 3.5x45 Giebelbretter - Gable boards 	18		
SR3 545	Schrauben - Screws 3.5x45 Traufenbretter - Eaves boards 	20		
SR5 0100	Schrauben - Screws 5.0x100 Fundamenthölzer - Foundation beams 	40		
Kood	VS44_0191 500x400 44 Elton	Materjal	Leht	2/6

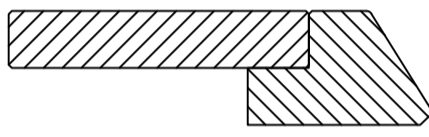
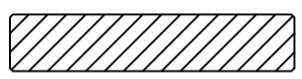
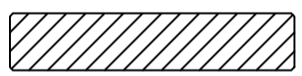
Pos	Teileliste/Specification VS44_0191 500x400 44 Elton		Stck./Pcs.	Profil/Profile (mm)	länge/Len (mm)
	FENSTER/WINDOW 650x1165 W3-S44P-06C-06501165 Q3 W117-PC 650  1165 Right handed/ DIN rechts paremakäeline Clear opening/ durchgangsmaß/ ava suurus 496x1011mm  double-pane clear float glass ISO Glas 2-fach 2x klaaspakett, kirgas klaas 439x944mm 		2		
PROSS H1-1	Q2-Q3-1 Muntins - Sprossen - Prossid horizontal 18x18		4	18x18	464
PROSS V2-1	Q2-Q3-2 Muntins - Sprossen - Prossid vertical 18x18		2	18x18	970
WL-1	Rain strips - Wasserleisten - Vihmaliistud 36x134		2	36x134	850
PL3-1	Trims - Rahmenleisten - Piirdeliistud 18x95	 ✓	4	18x95	850
PL3-2	Trims - Rahmenleisten - Piirdeliistud 18x95	 ✓	8	18x95	1245
PL3-3	Trims - Rahmenleisten - Piirdeliistud 18x95	 ✓	4	18x95	610
SR30 22-01	3.0x20ÜP Muntins - Sprossen - Prossid		12		
SR35 45-01	3.5x45 Trims - Rahmleisten - Piirdeliistud		56		
SR40 60-01	4.0x60 Rain strip - Wasserleiste - Vihmaliist		6		
AL-Q 2-Q3	Q2-Q3 Window handle - Fenstergriff - Aknalink		4		
Kood	VS44_0191 500x400 44 Elton				
		Materjal			
				Leht	4/6

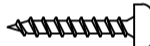
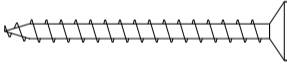
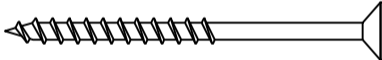
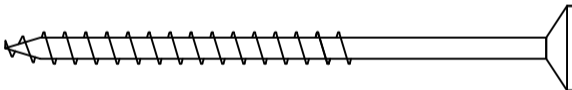
Pos	Teileliste/Specification VS44_0191 500x400 44 Elton	Stck./Pcs.	Profil/Profile (mm)	länge/Length (mm)	
	<p>FENSTER/WINDOW 650x1165 W3-S44V-06C-06501165</p> <div style="display: flex; align-items: center;"> <div style="margin-right: 20px;"> <p>Q3 W117-VC 650</p>  </div> <div style="border: 1px solid black; padding: 5px; margin-right: 20px;"> <p>Left handed/ DIN links vasakukäeline</p> </div> <div style="border: 1px solid black; padding: 5px; margin-right: 20px;"> <p>Clear opening/ durchgangsmaß/ ava suurus 496x1011mm</p>  </div> <div style="border: 1px solid black; padding: 5px;"> <p>double-pane clear float glass ISO Glas 2-fach 2x klaaspakett, kirkas klaas</p>  <p>439x944mm</p> </div> </div>	2			
PROSS H1-1	Q2-Q3-1 Muntins - Sprossen - Prossid horizontal 18x18		4	18x18	464
PROSS V2-1	Q2-Q3-2 Muntins - Sprossen - Prossid vertical 18x18		2	18x18	970
WL-1	Rain strips - Wasserleisten - Vihmaliistud 36x134		2	36x134	850
PL3-1	Trims - Rahmenleisten - Piirdeliistud 18x95	 ✓	4	18x95	850
PL3-2	Trims - Rahmenleisten - Piirdeliistud 18x95	 ✓	8	18x95	1245
PL3-3	Trims - Rahmenleisten - Piirdeliistud 18x95	 ✓	4	18x95	610
SR30 22-01	3.0x20ÜP Muntins - Sprossen - Prossid		12		
SR35 45-01	3.5x45 Trims - Rahmleisten - Piirdeliistud		56		
SR40 60-01	4.0x60 Rain strip - Wasserleiste - Vihmaliist		6		
AL-Q 2-Q3	Q2-Q3 Window handle - Fenstergriff - Aknalink		4		
Kood	VS44_0191 500x400 44 Elton	Materjal		Leht	5/6

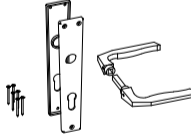
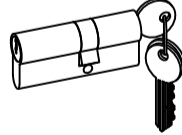
Pos	Teieliste/Specification VS44_0191 500x400 44 Elton	Stck./Pcs.	Profil/Profile (mm)	Äänge/Länge (mm)	
	<p>TÜR/DOOR 1580x1905 D3-D44R-01C-15801905</p> <p>Q3 D202-RC 1580</p>  <p>Right handed / DIN rechts / paremakäeline</p> <p>Clear opening/ durchgangsmaß/ ava suurus 1452x1797mm</p>  <p>double-pane clear float glass ISO Glas 2-fach 2x klaaspakett, kirgas klaas</p>  <p>550x1529mm</p>	1			
PROSS H1-2	Q2-Q3-1 Muntins - Sprossen - Prossid horizontal 18x18		8	18x18	575
PROSS V2-2	Q2-Q3-2 Muntins - Sprossen - Prossid vertical 18x18		2	18x18	1555
WL-2	Rain strips - Wasserleisten - Vihmaliistud 36x134		1	36x134	1780
PL3-4	Trims - Rahmenleisten - Piirdeliistud 18x95	 ✓	4	18x95	1885
PL3-5	Trims - Rahmenleisten - Piirdeliistud 18x95	 ✓	2	18x95	1780
SR25 15-01	2.5x15 Locking plate - Schließblech - Riivi vastus 01 Q2-Q3		2		
SR30 22-01	3.0x20ÜP Muntins - Sprossen - Prossid		20		
SR35 45-01	3.5x45 Trims - Rahmleisten - Piirdeliistud		24		
SR40 60-01	4.0x60 Rain strip - Wasserleiste - Vihmaliist		4		
SR50 90-01	5.0x90 Door frames - Türrahmen - Ukselengid		8		
RV01	Locking plate - Schließblech - Riivi vastus 01 Q2-Q3		1		
UL-Q 2-Q3	Q2-Q3 Door handle - Türgriff - Ukselink		1		
LS-Q4	Q4 Cylinder lock - Zylinderschloss - Lukusüdamik		1		
Kood	VS44_0191 500x400 44 Elton	Materjal		Leht	6/6

Vihmaliist / Rain strip / Wasserleiste

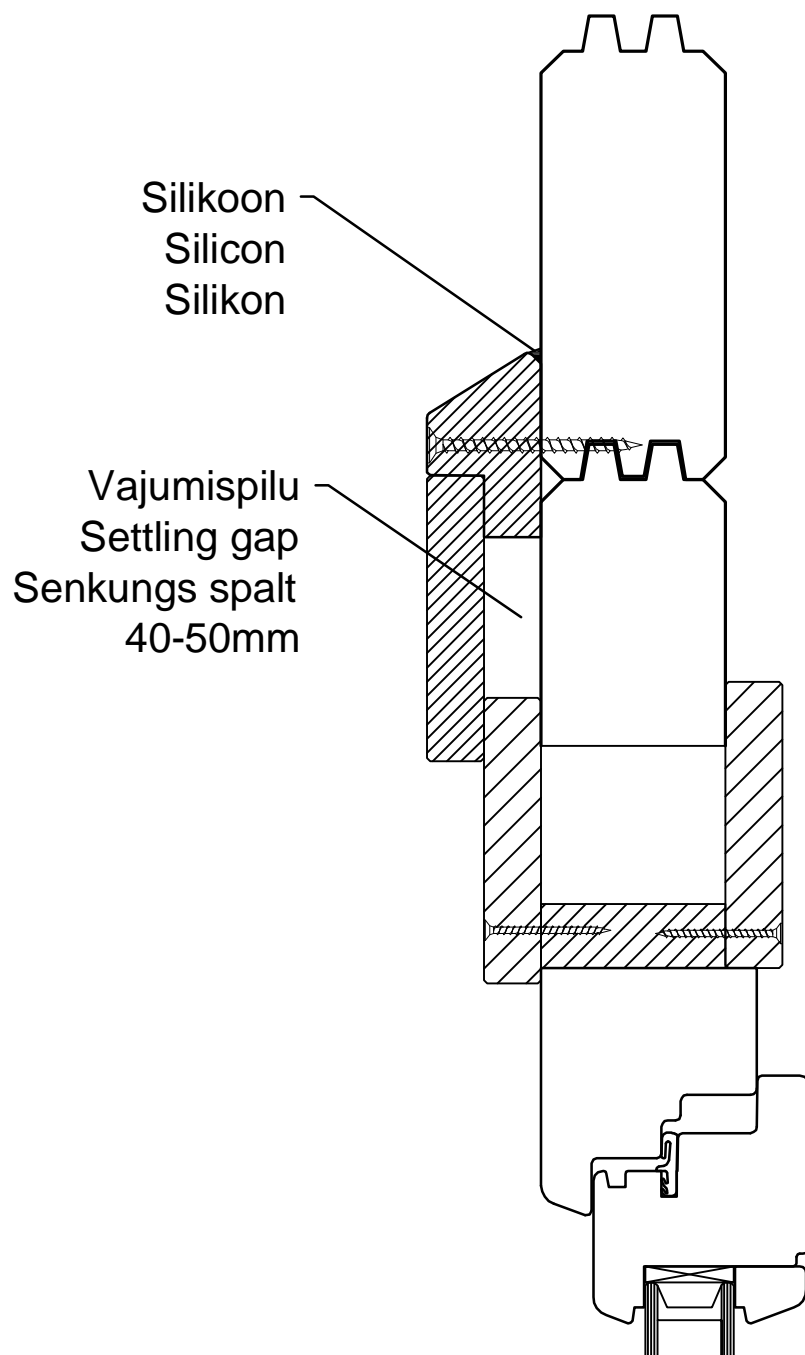

NB!

- Monteerida juhul kui ese on välja toodud maja spetsifikatsioonis!
- Install only if the item is listed in the house specification!
- Nur montieren wenn die Leiste in der Teileliste gezeigt ist!

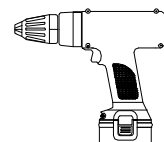

1

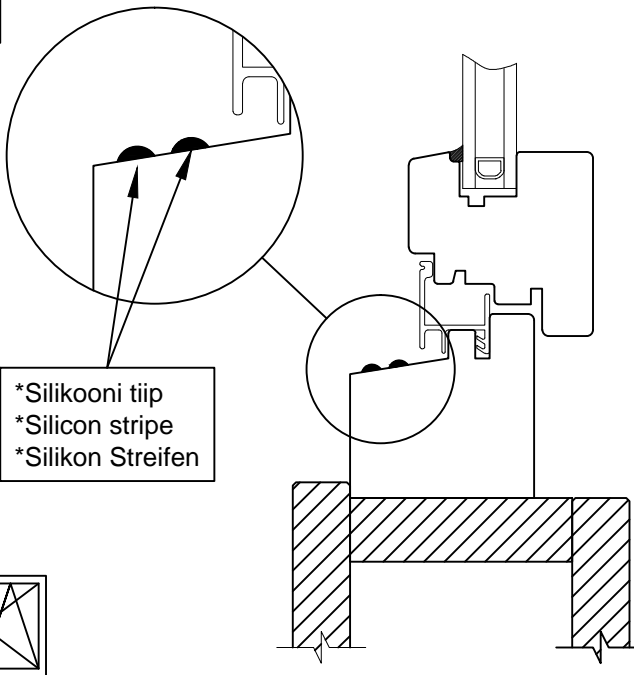

*Silikooni tiip
*Silicon stripe
*Silikon Streifen

2

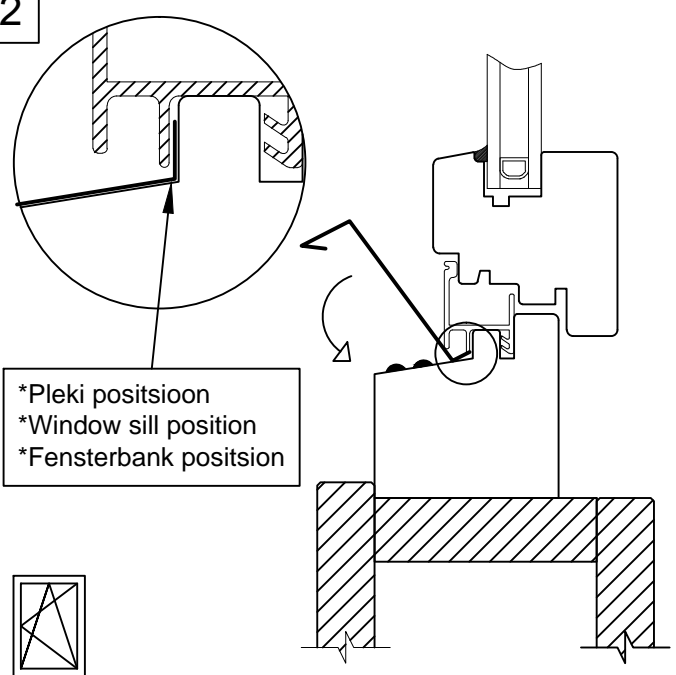

*Pleki positsioon
*Window sill position
*Fensterbank position

3

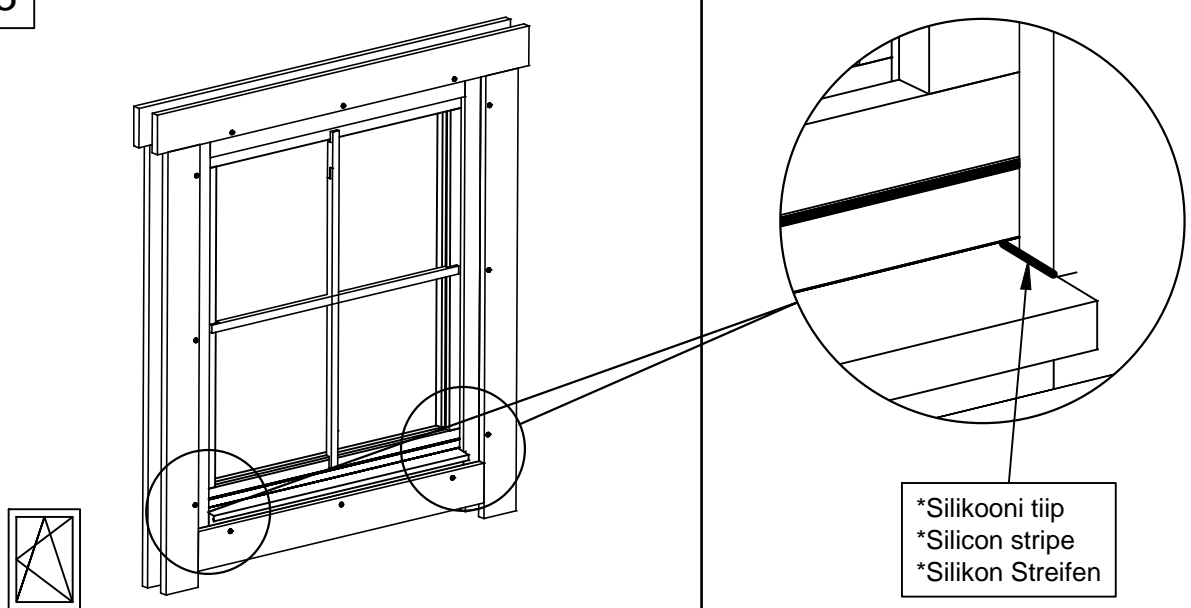

*Silikooni tiip
*Silicon stripe
*Silikon Streifen

1

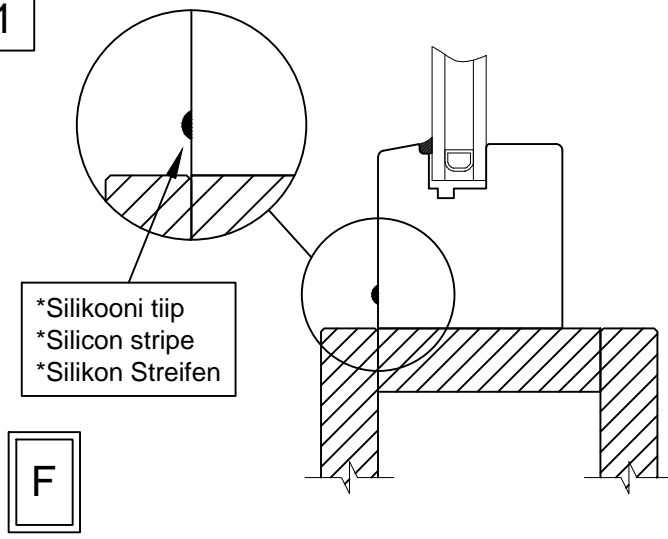

*Silikooni tiip
*Silicon stripe
*Silikon Streifen

2

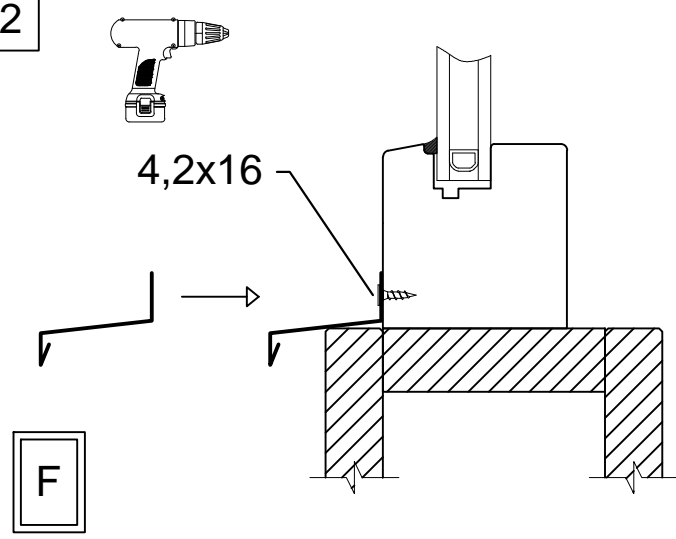

4,2x16

Aken	Q4-Q6	-	paigaldusjuhhis
Window	Q4-Q6	-	assembly instructions
Fenster	Q4-Q6	-	Montageanleitung

